

FRAME LETTER	DIM "A"	DIM "B"
V	31.09	11.62
VA	32.71	13.25

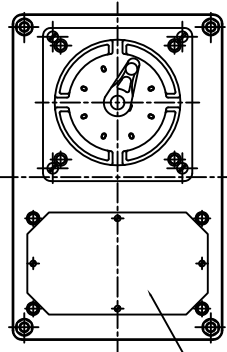

PRIMARY CONNECTION

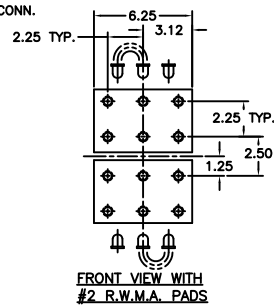
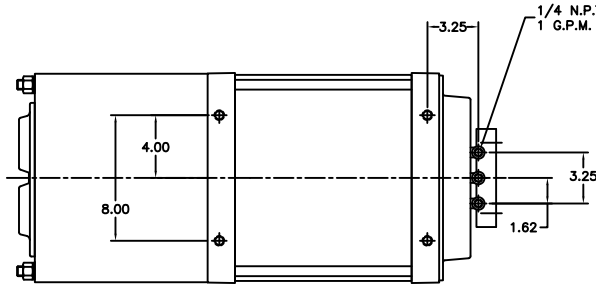
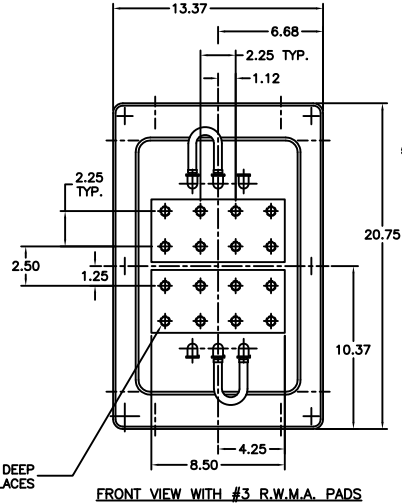
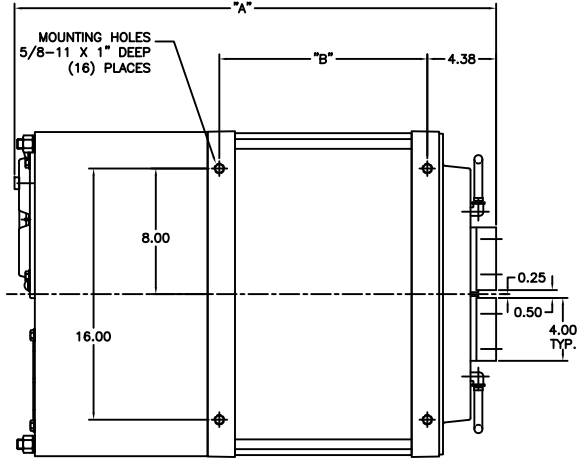

5/8-11 TAP X 0.75 DP (24) PLACES

WATER "IN"

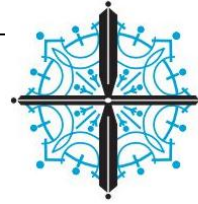
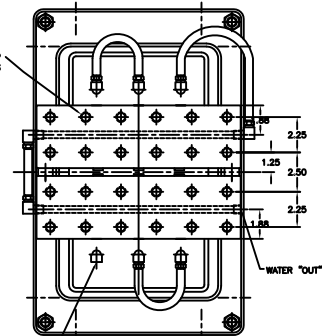

T. J. SNOW CO.

120 Nowlin Lane • P.O. Box 22847
 Chattanooga, Tennessee 37421
 Phone: (423) 894-6234 • Fax: (423) 892-3889
 welders@tjsnow.com or www.tjsnow.com



MACHINE TYPE TRANSFORMER
 TAP SWITCH: END MOUNT
 FRAME CROSS SECTION: 13.37" X 20.75"

DRAWING NO. R1286
 DATE: OCT. 1982

REV. E
 OCT 2012

REV	DESCRIPTION	DATE
E	ADDED 34" TO DIM "A"	28OCT12
D	ADDED VIEW OF FRAME #4 PADS	17OCT12
C	UPDATED HOUSING VIEW	11May10
B	CHANGED FRACTIONS TO DECIMALS	28Mar08
A	CHANGED OVER TO CAD	28Mar08

DATE	BY	CHECKED	DATE
28Jun08	28Jun08	28Jun08	28Jun08

WELD: NONE
 DRW: 28Jun08
 CAT: 28Jun08
 TJSNOW
 R1286